

P/N: FAPL09H-801Y1R0

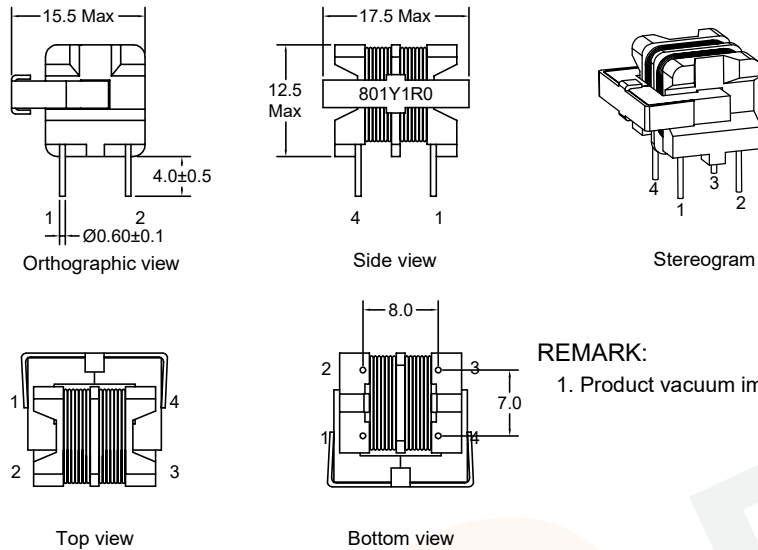

Outline Dimensions (Unit:mm)



REMARK:
1. Product vacuum impregnation.

Electronical Schematic



Winding Construction:

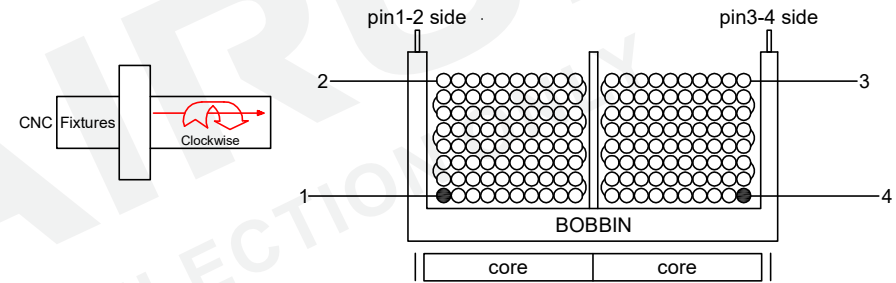

Electrical Characteristics

Inductance : L1-2=4-3= 0.80mH Min,at 10KHz,0.1V.
Rated current : 1000mA.
D.C.Resistance : 1-2= 0.11 ohms Max.
4-3= 0.11 ohms Max.
Turns Ratio : Wdg1:Wdg2=1:1±1%,at 20KHz,1V.
Hipot : Coil-Coil : 1500VAC/3mA/2S.

List of UL Certificate:

No.	Part Name	Mat'l Description	Supplier	UL Number
1	Bobbin	UU-0901/T375J	Chang Chun Plastics Co Ltd	E59481
2	Copper wire	2UEW-F/155C	Dong Guan YiDa Industrial Co Ltd	E344055
		2UEW-F/155C	Elektrisola Hangzhou Co Ltd	E258243
3	Core	UU9.8 TS10	TDG Holding Co Ltd	N/A
		UU9.8 GH10	Su Zhou Guanda Magnet Co Ltd	N/A
4	Clip	UU9.8/SUS301	Chuangshun Hardware Electronic Factory	N/A
5	Varnish	T-4260(a)/MW80-C	SuZhou TaiHu Electric Advanced Material Co Ltd	E228349

				Tianchang Fuan Electronic Co Ltd www.fuantronics.net TEL: +86-550-7814888 FAX: +86-550-7831133		 Tolerances unless otherwise specified: (X)±0.50 (XX)±0.25 Unit of measurement: mm		Make: Qiumei.Liu Checked: Beson. zhan Approved: Anson. zhan		DRAWING TITLE UU9.8 COMMON-CODE FILTER INDUCTOR Material Number: A24PL098S230		Customer P/N: Document/Rev: 00 Specification Sheet: 1 of 2 Date of Recognition: Jan./02/2020	
REV	DESCRIPTION	APPD	DATE										

P/N: FAPL09H-801Y1R0



General Properties:

Operating Temperature: -40°C to +125°C
 (Temperature rise included).
 Storage Temperature: -25°C to +85°C.
 Storage Humidity: RH10%~70%.
 Weight: ≈4.2g.

Wave Soldering



Note:
 1. Never Contact the ceramic with the iron tip;
 2. 1.0mm tip diameter(max).

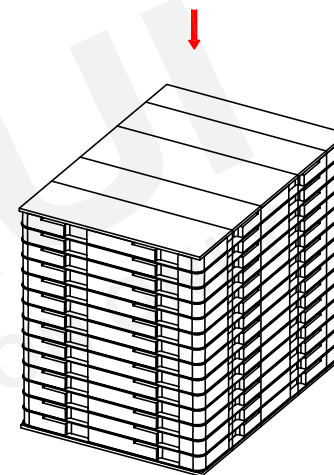
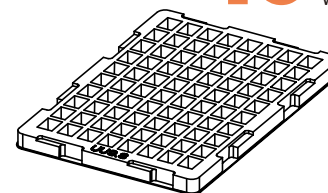

Quantity: 1120pcs/Reel

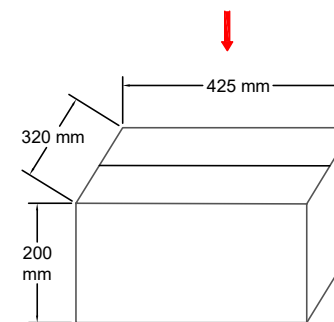

Outer cases: 2240pcs/box
 Insufficient boxes filled with inner boxes or fillers

Packaging Specification:

Blister tray:

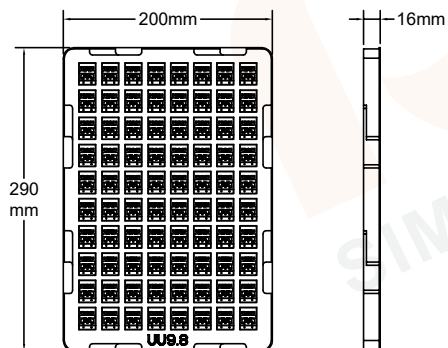

- 1. 80 products are placed on one blister disc, 14 blister discs are fixed together, and a cardboard is placed at the top and bottom respectively.
- 2. 28 plastic suction cups (2240 pcs) in one box.
- 3. Blister tray: UU9.8.
 Carboard: 295*200*3mm.
 Carton: 450*320*200mm.

				Tianchang Fuan Electronic Co Ltd www.fuantronics.net TEL: +86-550-7814888 FAX: +86-550-7831133	Tolerances unless otherwise specified: (X)±0.50 (XX)±0.25 Unit of measurement: mm	Make: Qiumei.Liu Checked: Beson. zhan Approved: Anson. zhan	DRAWING TITLE UU9.8 COMMON-CODE FILTER INDUCTOR Material Number: A24PL098S230	Customer P/N: Document/Rev: 00 Specification Sheet: 2 of 2 Date of Recognition: Jan./02/2020
REV	DESCRIPTION	APPD	DATE					